

## 2000 International Technical Rescue Symposium

# Comparative Testing of High Strength Cord

**Tom Moyer**

**Paul Tusting, Chris Harmston,**

(© Tom Moyer)

Complete test data for the results presented in this paper can be found at

<http://www.xmission.com/~tmoyer/testing>

Chris Harmston and Paul Tusting are employees of Black Diamond Equipment, the manufacturer of a product evaluated in this paper. All effort has been made to present the information here impartially. This paper presents the results of testing of many products. It does not represent the official position of Black Diamond Equipment.

### Abstract

Many climbers carry an 18-foot length of accessory cord called a cordelette for rigging anchors and as a tool for self-rescue situations. In the past, this cord was usually 7mm Nylon. In recent years, many climbers have changed to using one of a number of high-strength materials in smaller diameters. Vectran, Technora, Spectra, Kevlar, Kevlar/Spectra blends and Spectra/Nylon webbing are all used for these purposes along with Nylon cord and Nylon webbing. These materials all have different properties, and in some applications, dramatically different performance. This study tests and compares the strength of different knots in these materials, in both static and dynamic loading, along with their resistance to cyclic flexing, in order to judge their suitability as tools for climbers and rescuers.

### Background

The use of Kevlar, Spectra and Vectran fibers to make high-strength rope was pioneered by the sailing industry, to take advantage of their high tensile strength, low elongation, and low moisture absorption. These materials gradually moved into climbing applications, first as chock cord and more recently as cordelette material, prusik cord, and emergency rappel line. In the climbing world they have been surrounded by a lot of mythology and little hard data. It has been said that tying and untying chock cord weakens it severely, that double fisherman's knots are not secure, triple fisherman's are needed, that Kevlar-based cords will self-abrade and eventually weaken, and that knots will not hold in Spectra/Nylon webbing. In recent years, manufacturers have been combining and improving materials, and climbers have been expanding their applications. Have the materials improved? Are the myths true? And most importantly, are these materials strong enough to use in these applications? This testing will provide some answers to these questions.

### Materials

#### ***Kevlar***

Kevlar was one of the first high-strength fibers to be used in rope. It still offers high tensile strength and very low elongation, but has poor fatigue properties. The fibers inside the rope abrade each other, offering little indication of the reduced strength until the rope breaks. Kevlar has a very high melting point, 500 C or 932 °F. Kevlar-core ropes are sold as escape lines for firefighters - to be used once and discarded. Manufacturers have had some success at solving the self-abrasion problem by combining Kevlar with Spectra.

#### ***Technora***

Technora, like Kevlar, is an aramid, but with vastly improved fatigue properties. It shares Kevlar's high tensile strength and high melting point.

#### ***Spectra***

Spectra is a very high molecular density form of polyethylene - the same thing used to make grocery bags, six-pack carriers and milk jugs. The manufacturing process aligns the molecules, which vastly increases the strength of the material. It is twice as strong as hardened steel (per unit area) and one-tenth the density. Spectra has several difficult issues. The melting point is very low, 147 C or 297 °F, not much warmer than boiling water. The material is unbelievably slippery, which makes it difficult for manufacturers to form into a workable rope. And, while the modulus of the fibers is comparable to steel, they slowly elongate under a continuous load. This process is called "creep." It is mostly irrelevant to climbers, but annoying to sailors. Spectra/Nylon is also known as Dyneema (a trade name of Beal Ropes) in Europe.

## **Vectran**

Vectran is a liquid crystal polymer - its properties are between those of crystalline solids and liquids. It has similar strength to Spectra, but without the creep problems. It has poor UV resistance, which is not a problem when used as the core in kernmantel rope construction.

Seven products were tested for this project. Sterling Vectran, Blue Water Titan, Black Diamond Gemini2, Maxim Spectra A, Mountain Tools Ultratape, Sterling 7mm Nylon accessory cord, and Liberty Mountain 1 inch Nylon Tubular Webbing.

Sterling Vectran has a Vectran core and a Nylon sheath - it is sold in precut lengths labeled "cordelette" in addition to spools. Blue Water Titan has a braided Spectra/Nylon core and a Nylon sheath. Black Diamond Gemini2 has a Technora core and a polyester sheath. It is identical to the product sold as "Tech Cord" by Maxim (New England Rope). The original Black Diamond Gemini was a different product, similar to Maxim's Spectra-A, and has not been sold in several years. Spectra-A has a braided Spectra/Kevlar core and a polyester sheath. It has largely been replaced by Tech Cord, but is still sold, usually at cheaper prices. Ultratape is a Spectra/Nylon webbing, constructed to minimize the amount of Spectra on the outside surface. This helps protect the Spectra from UV damage, and lets knots hold better, since more Nylon is in contact.

## **Applications**

The cordelette has become the favored tool of climbers for a quick, convenient and redundant anchor, using a minimum of gear. It also doubles as an extremely useful self-rescue tool, or can be cut up and left as rappel anchors when retreating off a climb. Mountain Tools has introduced the concept of the Web-o-lette™, a long runner, with sewn eyes in each end. This makes the same 3 point tied-off anchor, but two of the pieces are clipped with only a single strand of webbing. This means the whole length of material can be reduced, which makes it lighter and less bulky on the harness.

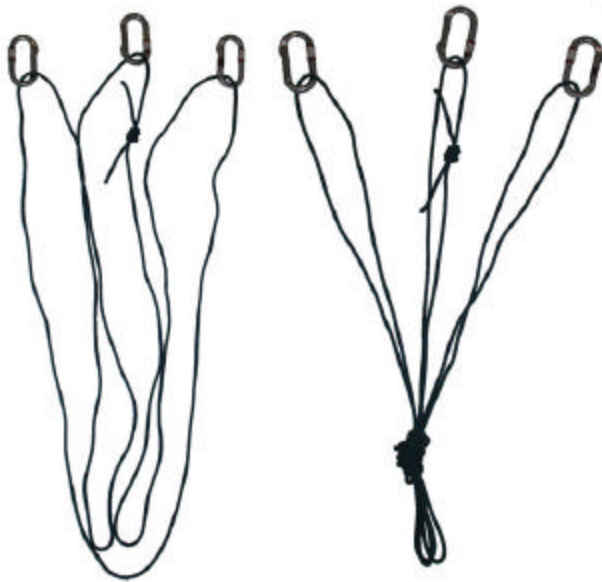

**Cordelette Anchor**



**Webolette Anchor**

(Karl Lew photo)

## **Test Methods**

### **Slow Pull Tests**

Slow pull tests were done on the 11,000-lb SATEC Apex 11 EMF universal test machine at Black Diamond. These were done on unknotted material over 4" diameter drums, on figure-eight knots, on loops tied with double fisherman's, triple fisherman's and water knots, and on a cordelette loaded on a single arm. Pull rates and fixtures were consistent with CEN standards. The material was not temperature and humidity conditioned, but all tests were done at 29% humidity  $\pm 4\%$  and at 71°F  $\pm 6^\circ$ . Five samples were tested in each material for each configuration and the results were averaged. One sample of various friction knots was also tested in each material on Black Diamond 10.5mm Cirrus dry-coated rope.

Keep in mind that an *average* breaking strength (the arithmetic mean) is not a good quantity to use to determine whether a component is strong enough. A *minimum* breaking strength - three standard deviations below the mean - is much more appropriate. However, five samples are not sufficient to determine a meaningful statistical minimum, so average strength is presented here.

### **Drop Tests**

Drop Tests were conducted at the Rocky Mountain Rescue Group drop tower in Boulder Colorado. The configuration modeled the UIAA and CEN drop test - a fall factor 1.71 fall on 2.8 meters of rope. A new section of 10.5mm Black Diamond Cirrus (nondry) rope was used for each test. This rope carries a UIAA rated impact force of 8.4 kN (1888 lb). The cordelette to be tested was placed at the location of the "pivot edge", or the direction change anchor. The force at this point should theoretically be twice the rope tension because of the direction change. In reality, carabiner friction reduces this to around 170%. The load was applied to the cordelette with carabiners, as it would be in a climbing fall. As in the slow pull tests, only one arm of the cordelette was clipped. In accordance with the CEN specifications, the weight was dropped once every five minutes until the cordelette had broken or sustained five falls without breaking.

### **Flex Cycle Test**

A cyclic flex test was run to check the fatigue performance of the different materials. A sample of cord passed through a horizontal hole in the fixture, flexed 90 degrees over a steel edge, and was loaded with a 40 lb weight. The fixture was rotated back and forth 180 degrees by a pneumatic actuator for a specified number of cycles, with all the flexing happening at the same point on the sample. The sample was then pull-tested over drums with the fatigued point in the free section to measure any reduction in tensile strength at that point.

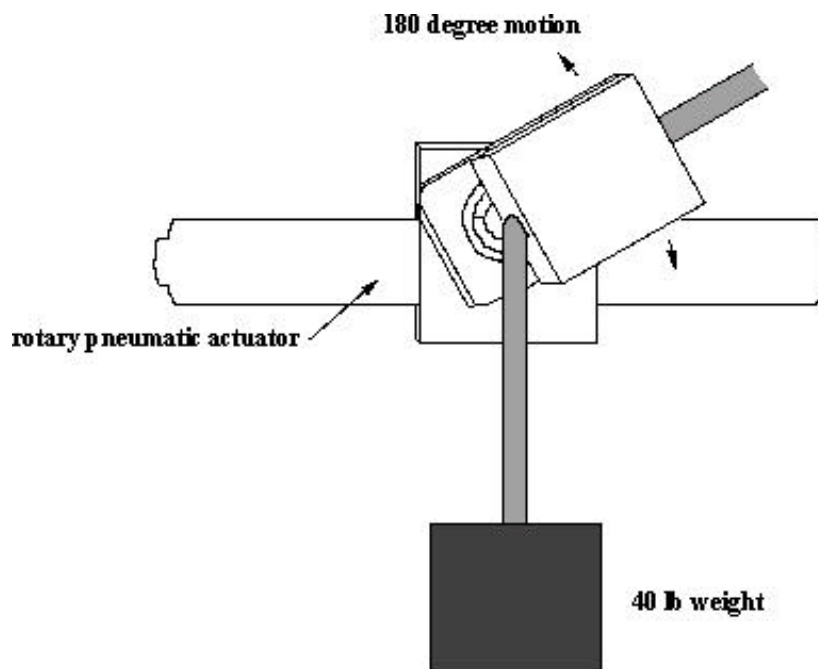

## **Results**

### **Slow Pull Tests**

The Technora and Kevlar/Spectra cords live up to their billing as having extraordinary tensile strength, but the story changes immediately when the cord is knotted. Knot efficiencies for a figure-eight knot ranged from 40% on the Gemini to 92% on the Nylon. For a double fisherman's knot, Gemini and Titan share an interesting failure mode. The sheath breaks at the knot and the slippery core unties, pulling through the sheath. When a triple fisherman's knot is tied, this does not happen. The strength gain for the triple fisherman's is not large, but it is enough to change the mechanism. The Ultratape - a Spectra/Nylon webbing - shows excellent strength in all of the knots, contradicting the popular belief that knots will not hold in this type of material. Testing is needed on webbing with a more conventional Spectra/Nylon weave to see if that conclusion can be extended to other products.

### Tensile Strength

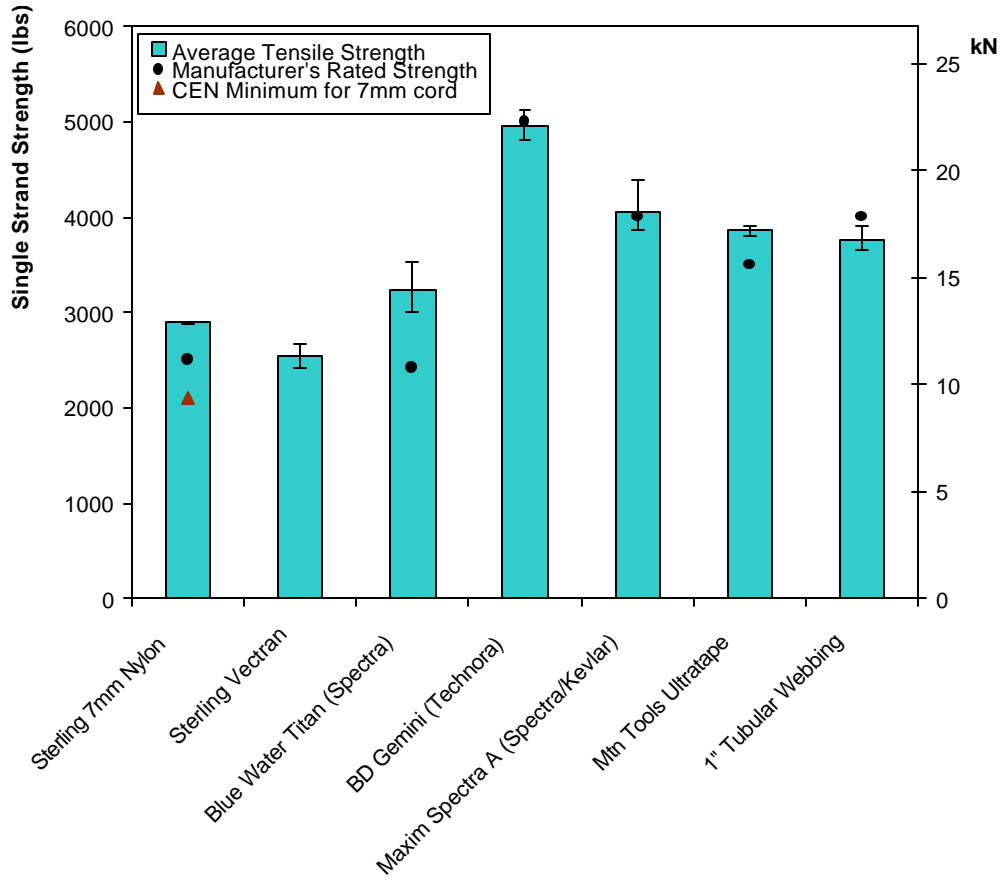

### Figure Eight Knot Comparison

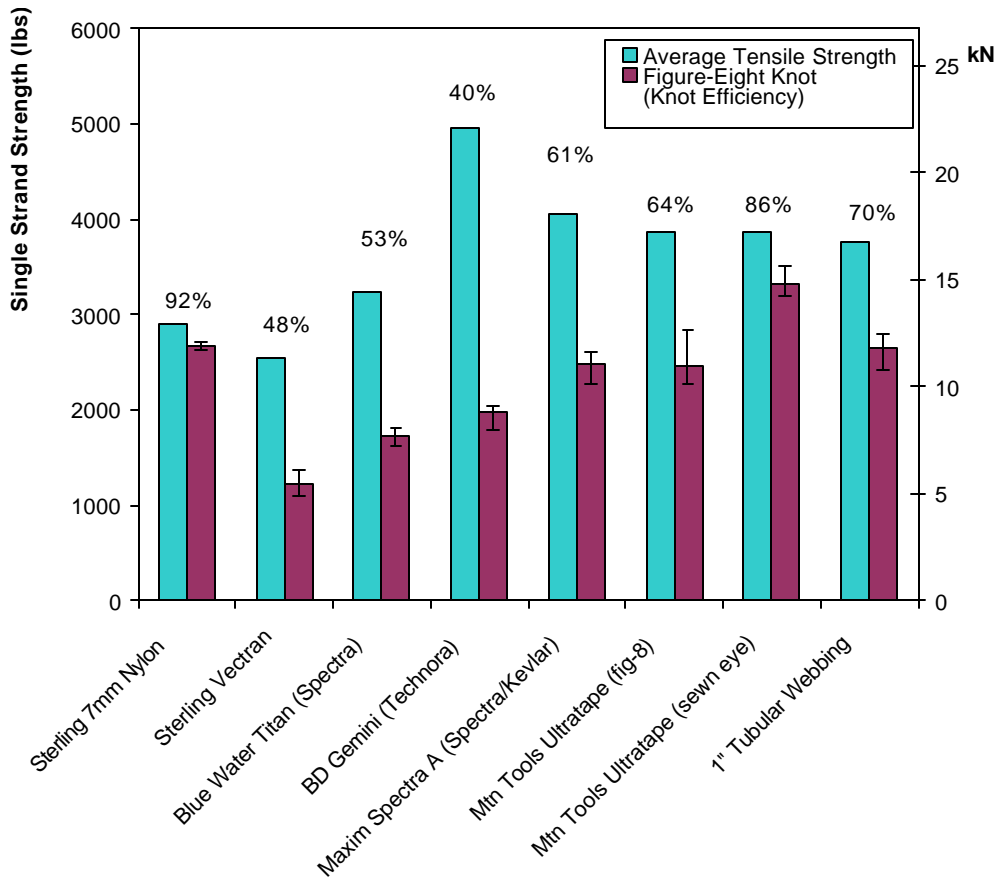

### Loop Knots (Bends) Comparison

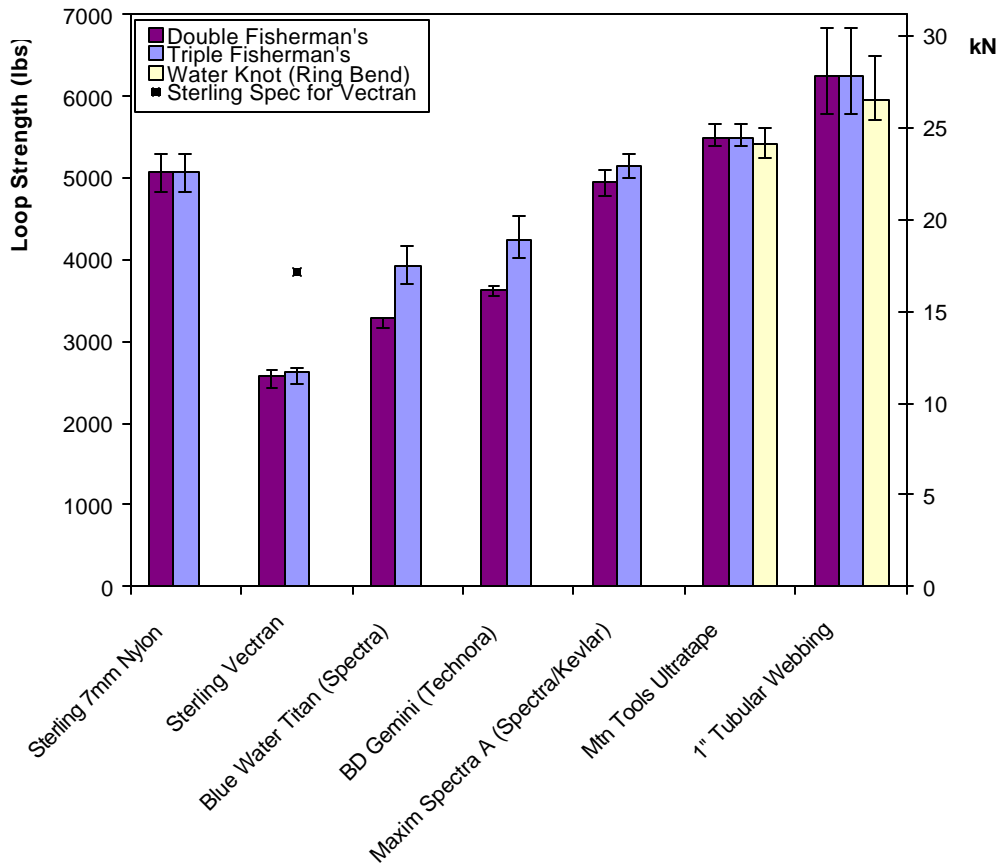

### Friction Knots

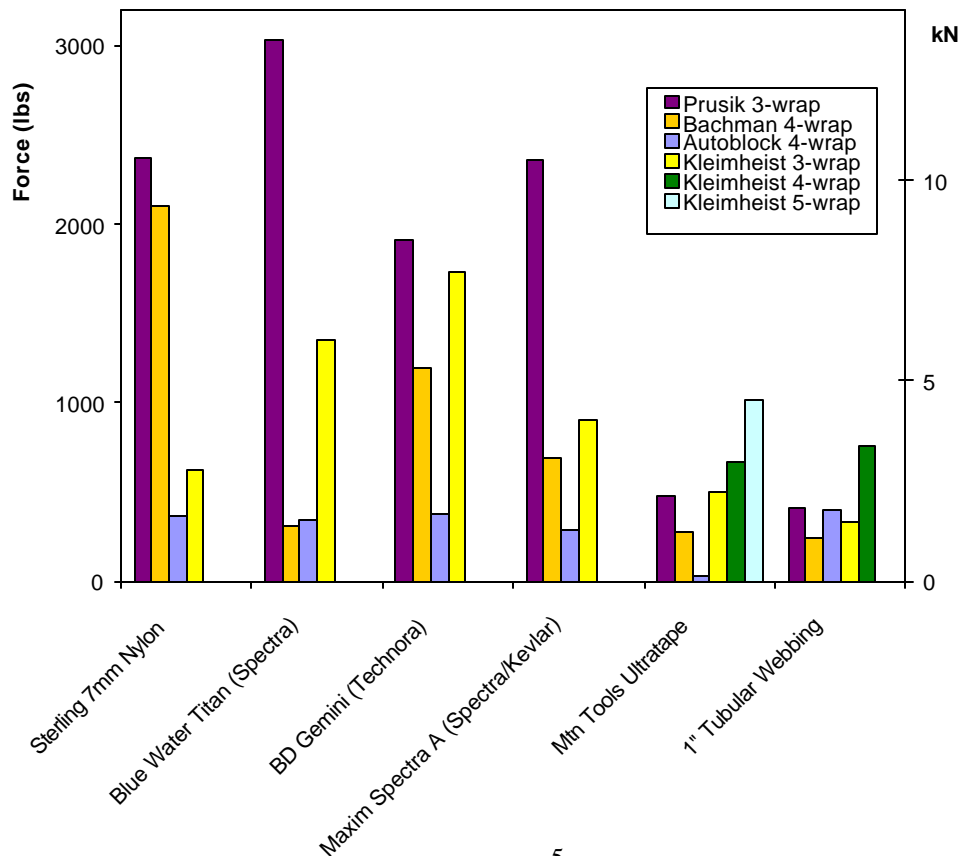

Friction knots were tested to determine whether there were any obvious reasons why any of these materials could not be used for ascending or as a self-rescue rope-grab. For all the cord materials, any of several friction knots work fine and the choice would be based simply on ease of tying and loosening in use. For the two webbing materials, it is tougher to get sufficient holding power. A climber can easily generate forces of 500 lb when ascending. If a hitch will not reliably hold that load, slipping will happen. For the webbing, adding wraps is the only way to get the holding power. The most convenient hitch to do this with is the Kleimheist. The fact that the Spectra/Nylon Ultratape can be used at all for friction knots also contradicts the conventional wisdom.

For the cordelette strength, both the strength of the weak arm (knotted or single-strand sewn) and the strength of the stronger arms are plotted. For most of the materials there is no difference. The material breaks at the pin or in the overhand cordelette knot. For the webolette, the weak arm is a single strand, so the double-strand leg is considerably stronger. Since these are used as anchors, the UIAA spec for maximum dynamic-rope impact force is shown for comparison. This represents a typical worst-case force on the rope. However, if the belay is run through the anchor, force on the anchor is multiplied. A level 170% of the UIAA spec - an assumed maximum - is also shown for comparison. It is apparent from this chart that at least some of these cordelettes would be expected to fail a UIAA drop test.

### Cordelette Strength

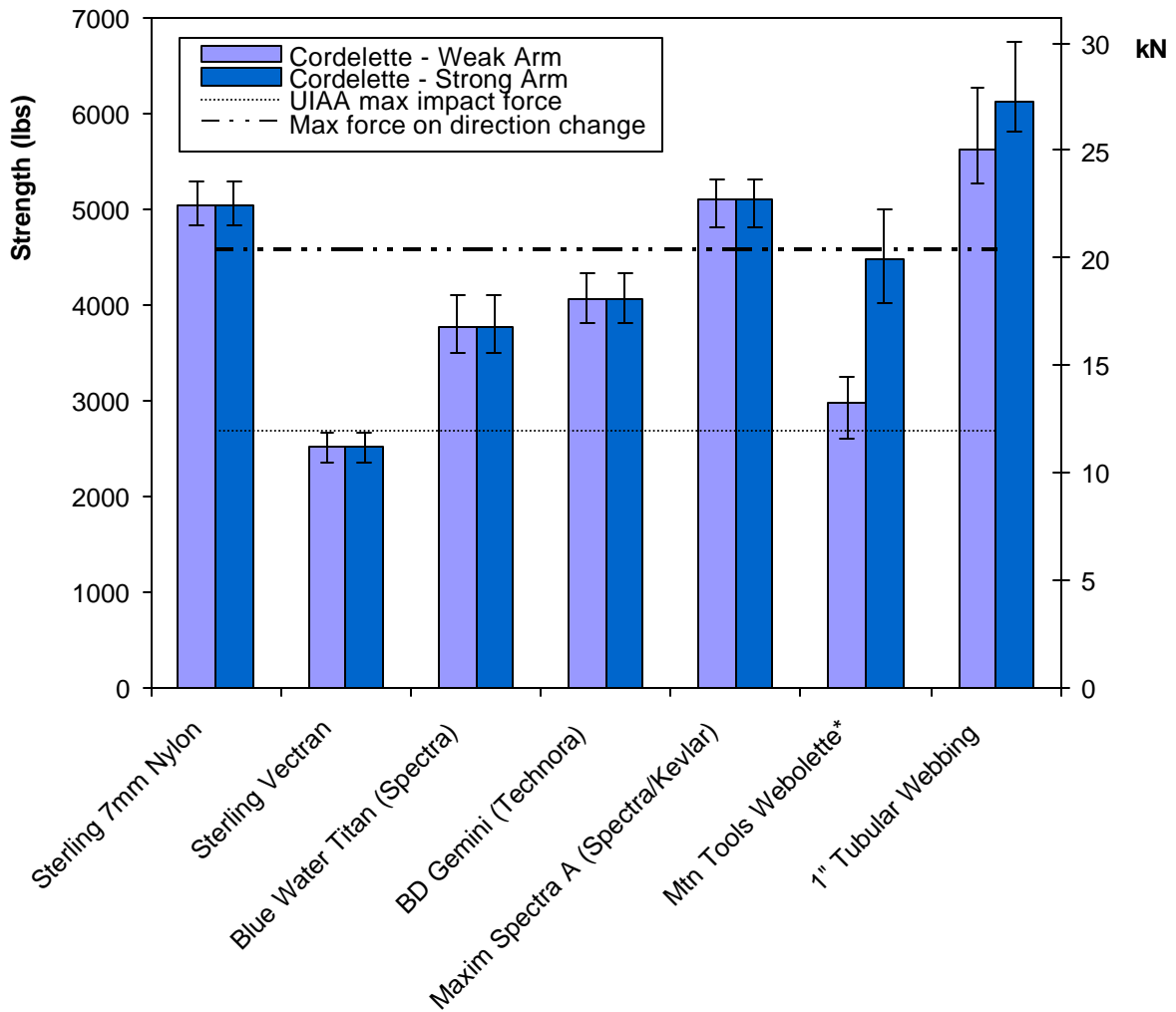

\* For the webolette, the weak arm is a single strand with a sewn eye. The strong arm is a double strand.

### Drop Tests

One might guess that some of the materials, particularly those with Spectra in the core, would be weaker when loaded dynamically than statically because of heat produced by energy dissipation in the knot. In fact, that turned out not to be the case. Every material failed at very close to the static failure load. The one that appears to be an exception, the Ultratape, was drop-tested in a non-standard configuration - with a tied eye rather than a sewn eye in the single strand. Horizontal lines in the chart show the average impact forces on the anchor for each drop. On each successive drop, the rope's modulus increases (it gets stiffer) and the impact force increases. Other than knot tightening, there was no evidence of any change to the cordelette with successive impacts. The Sterling Vectran failed on the first drop, raising some serious questions about its suitability as a cordelette material. Keep in mind that the rope used in the testing has a relatively low impact force rating of 8.4 kN, nowhere close to the UIAA limit. In addition, rope modulus increases with age and use, so older ropes would be expected to place a higher impact force on the anchor. 7mm Nylon and Maxim Spectra-A did not fail in five drops. Tubular Nylon webbing was not tested, but it is assumed from its slow-pull strength that it would not have failed in drop testing.

**Cordelette Drop Tests**

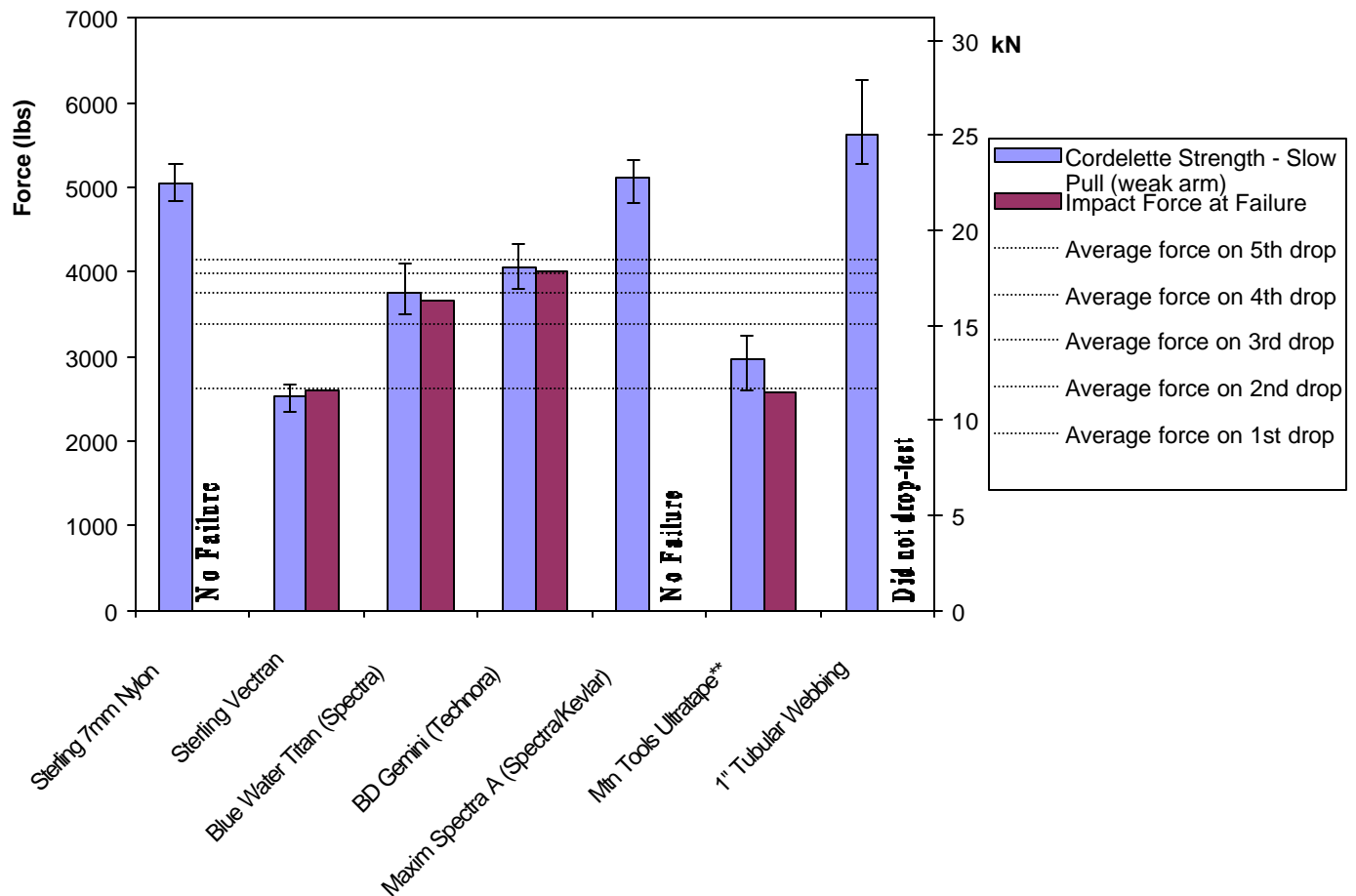

\*\* Ultratape was tested with a sewn eye in the pull-tests and a tied eye in the drop-tests.

### Flex Cycle Test

The results of this test were a surprise. One might expect to see linearly descending strengths, with different slopes for different materials. Instead, Nylon and the Spectra/Nylon webbing show *no* drop in strength over the test, and Technora, Spectra-A, and Vectran all show an immediate and dramatic reduction in strength, but at higher cycles, the curve flattens and little further strength appears to be lost. Since the effect happens so quickly, a used piece might show this strength loss everywhere along its length. The knot efficiencies for these materials, which are very low in new material, may be higher when the cord is used and more flexible, but further testing is needed to determine this.

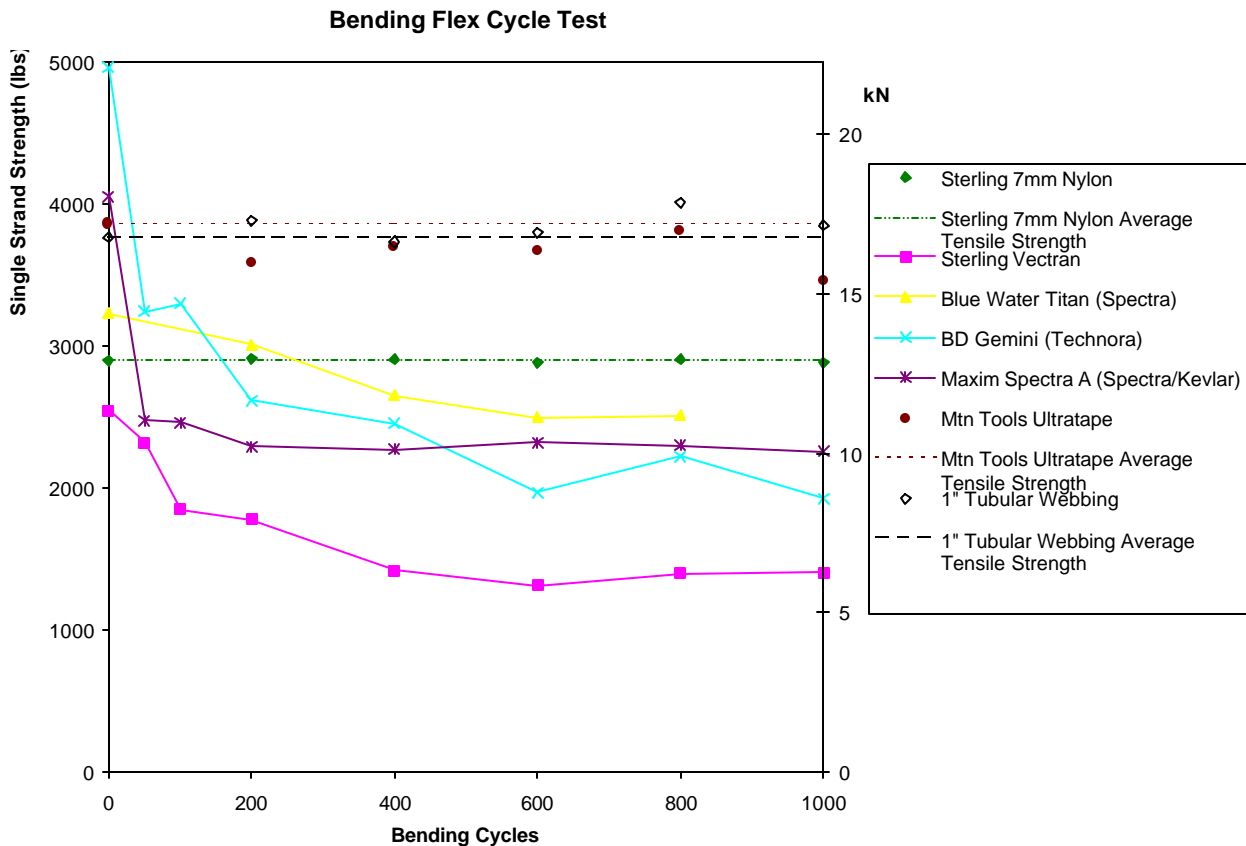

## Conclusions

How strong should your anchor be? One arm of a Vectran cordelette, for example, fails at only 2600 lb (11.5 kN). This is little stronger than a good carabiner in the open-gate mode - and the material gets weaker with use. Is this strong enough? One can easily argue that the drop test we performed is unduly harsh. First, it uses a completely static belay. A sticht-plate or tube belay-device can reduce the peak impact forces significantly. Second, the lead rope is run through the central anchor point. This practice increases the load at the anchor. Third, the test loaded only one arm of a cordelette. While the cordelette anchor does not equalize when the belayer shifts position, there is typically enough stretch in each arm that all three will be loaded to varying degrees in a major impact. Fourth, Chris Harmston, Black Diamond's Quality Assurance Manager, has reviewed field failures of climbing gear for eight years. He has never seen a stopper rated at over 10 kN fail, and has seen only a few carabiners fail in closed-gate mode. He believes that forces exceeding 10kN rarely happen in climbing falls.

All that said, we do not think it is unreasonable to expect one arm of the anchor to hold at least *one* UIAA fall on a soft rope when both the rope and the cordelette material are new! The decrease in strength with use is a worry for any of the Technora, Kevlar or Vectran materials. The Gemini and the Spectra-A are also extremely stiff and difficult to tie and untie. An 18-foot piece makes a bulky object hanging from the harness. They make excellent chock cord (where a stiff cord is desirable), but would make a poor cordelette. Among the high-strength cords, Titan seems to be the most suitable material for cordelettes. The Ultratape is even better, and the webolette is an elegant solution to multi-point anchors, although we'd prefer to see slightly higher strength on the single-strand arms. Last, Nylon cord and webbing may be the best of all. Although heavier, they are cheap, strong, universally available, and seem to have a virtually unlimited flex life.

## Acknowledgements

Black Diamond provided test material and made their test lab available for this project. Sterling Rope, Blue Water Rope, New England Rope, and Mountain Tools all provided material for testing. Karl Lew asked these same questions a year ago and provided samples for earlier testing in the BD test lab on this subject. Bill May, Lewis Dahm, John Snyder, Jim Gallo, Scott Whitehead, Dave Hibl and others from the Rocky Mountain Rescue Group in Boulder worked hard to get their new drop tower up and running in time for it to be used for this project. Sensotec provided the load cell used to measure forces at the drop-tower. Without all of these contributions, this testing would not have occurred. Thanks everyone.